

Dimensions & Specifications

When mounting the JET REEL™ (JR33) in the front

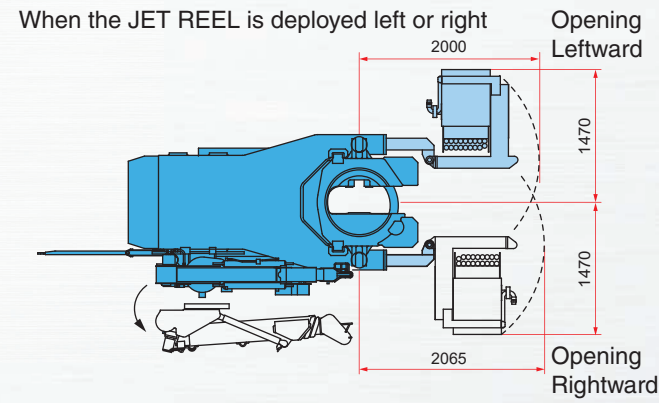

When installing 500 mm wide sheet piles

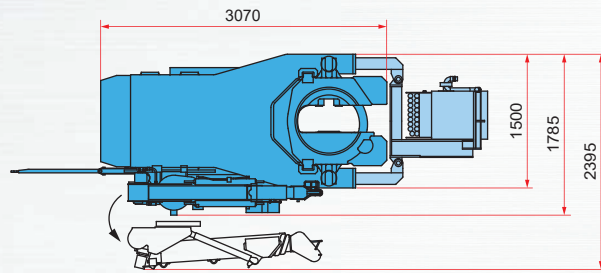
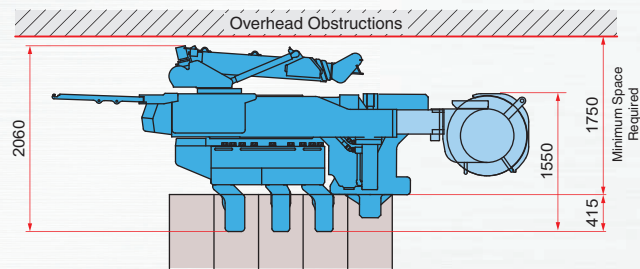

When installing 600 mm wide sheet piles

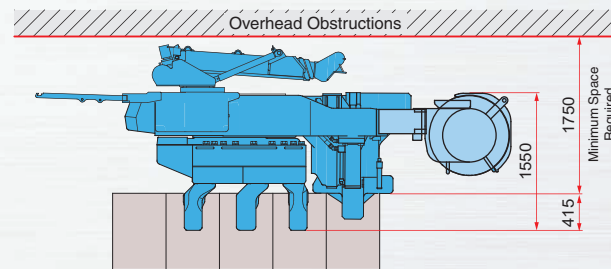

Power Unit

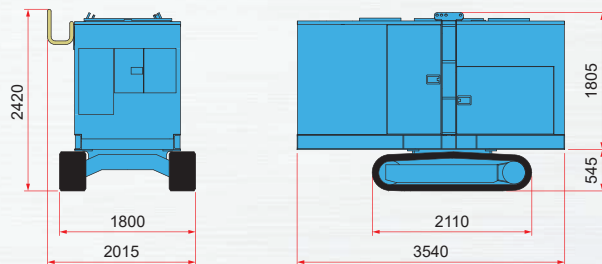

Power Unit		EU200N4
Power Source		Diesel Engine
Rated Output	Power Mode	162 kW (220 ps) /1800 min ⁻¹
	Eco Mode	144 kW (196 ps) /1600 min ⁻¹
	Super Eco Mode	126 kW (171 ps) /1400 min ⁻¹
Fuel Tank Capacity		350 L
Hydraulic Reservoir		490 L (PILER ECO OIL)
AdBlue®/DEF Tank Capacity		38 L
Moving Speed		1.4 km/h
Total Mass		6000 kg (with standard 40 m horses)

Press-in Machine Main Body		CLW100
Applicable Piles		U Sheet Pile 500 mm VL, VIL U Sheet Pile 600 mm Illw, Ilvw
Max. Press-in Force		1000 kN
Max. Extraction Force		1100 kN
Stroke		600 mm
Press-in Speed		1.9 - 15.2 m/min
Extraction Speed		1.8 - 15.1 m/min
Control System		Radio Control
Crane Lifting Capacity		0.7 t x 3.8 m
Crane Boom Length		1.77 m - 4.05 m (three telescoping)
Crane Control System		Radio Control
Mass	Press-in Machine Main Body	8790 kg
	Crane Unit	630 kg
Total Mass		9420 kg

PILER JET REEL™		JR33
Applicable Piles		29 m as standard (Max. 34 m)
Mass		750 kg

Transportation Stand		
Mass		500 kg

Backward Self-moving Attachment		AM192
Mass		810 kg

*The above specifications are subject to alternation without prior notice.

SILENT PILER™

Low-headroom Press-in Machine

CLW100

Overhead Clearance Method
For 500 mm • 600 mm wide U Sheet Pile



GIKEN

Construction Solutions Company

www.giken.com

CONTACT US



GIKEN

"SILENT PILER" is a registered trademark or trademark of GIKEN LTD. in the United States and other countries.

© 2021 GIKEN LTD. All Rights Reserved.

Ver 1.0EN01 / 04 Jul 2023

SILENT PILER™ Press-in machine dedicated for sites where overhead clearance is limited

Improved Construction Efficiency with 600 mm Wide Sheet Piles

SILENT PILER CLW100 is a specialised press-in machine designed for installing sheet piles in areas with limited overhead clearance, such as under bridges and high-voltage power lines. These areas have been difficult to work with using traditional press-in machines.

This machine can handle 500 mm and even 600 mm wide U-shaped sheet piles, which previous models could not. This leads to significantly reduced construction time and costs. It also makes on-site work more efficient and labour-saving with several improvements, including a re-structured chuck, automated basic self-moving operations, and a lighter main body.

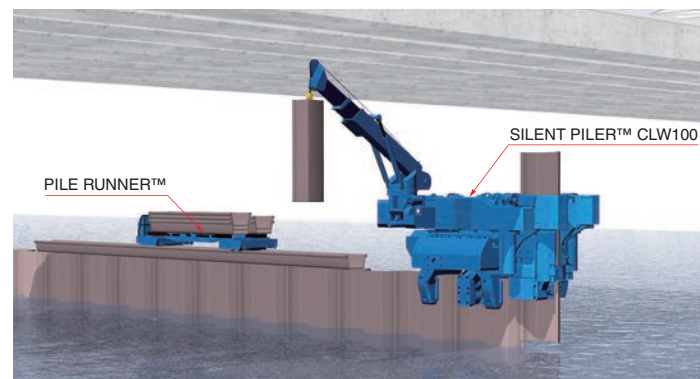

■ Use of a Front-opening Chuck to Pitch a Pile

The arm in the front part of the chuck opens to allow the maximum length of sheet piles to be pitched based on each on-site condition. You can perform a series of operations from unlocking to opening the arm or from closing the arm to locking by pressing and holding a button. Also, each operation: Open/Close or Lock/Unlock, can be easily performed with a single button press.



Chuck Front: Arm Closed

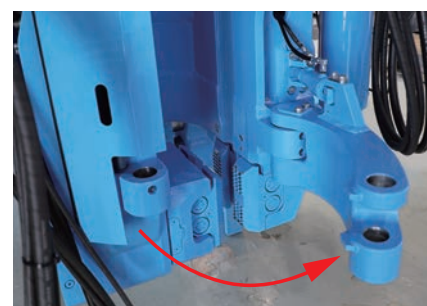

Chuck Front: Arm Open

■ Automation of Basic Self-moving Operations

One-touch operation from Main Body Up - Saddle Forward - Clamp Left/Right swap reduces the workload for the operator.

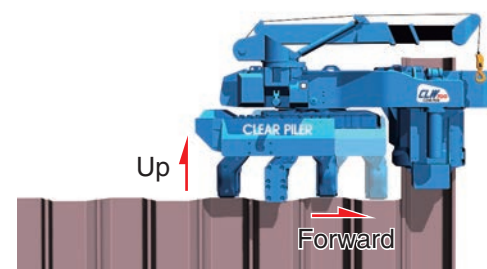

■ Automatic Boom Stop Function with Height Adjustability

When the top of the boom reaches the set height, an alarm buzzer sounds and the lifting device automatically stops to ensure work safety.

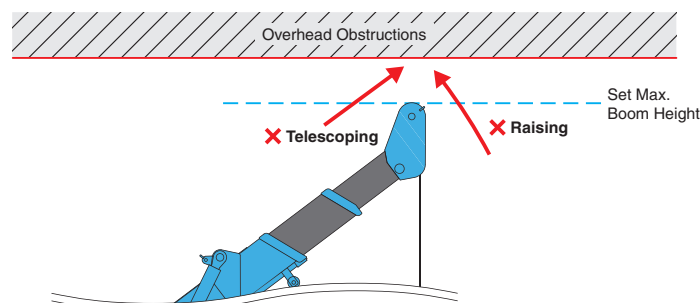

■ Lightweight Body

The CLW100 is an improved model with more pile options: It can handle 500 mm and 600 mm wide U-shaped sheet piles and is even lighter than the other model CLF120.

Model	CLF120	CLW100
Appl. Pile Width	500 mm	500 mm, 600 mm
Mass	9650 kg	8790 kg

■ Use of a New Model of PILER JET REEL™

Increased hose windings allow longer sheet piles of up to 34 m in length to be installed.



Standard Machine Layout

When using a work barge

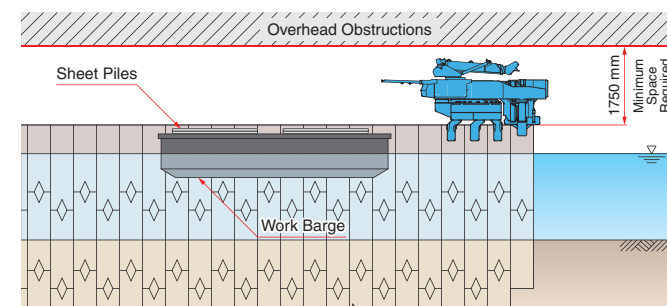

When using PILE RUNNER™*1

*1 PILE RUNNER is not included in this product.

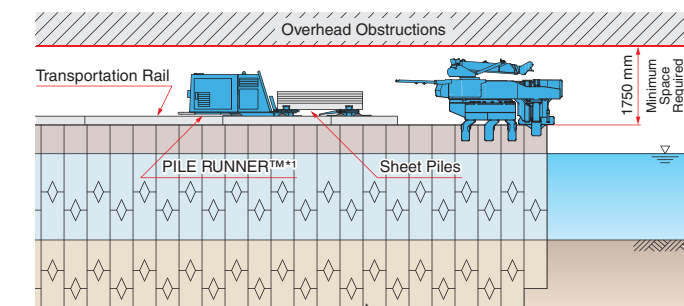

Corner Installation

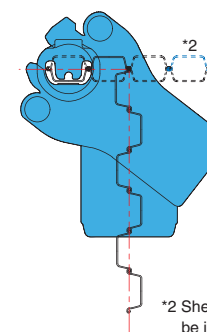

Curve Installation

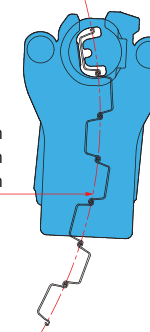

Minimum radius*3
500P VL: 4800 mm
500P VL: 5000 mm
600P : 5700 mm

*2 Sheet piles cannot be installed in this area.

Slope Installation

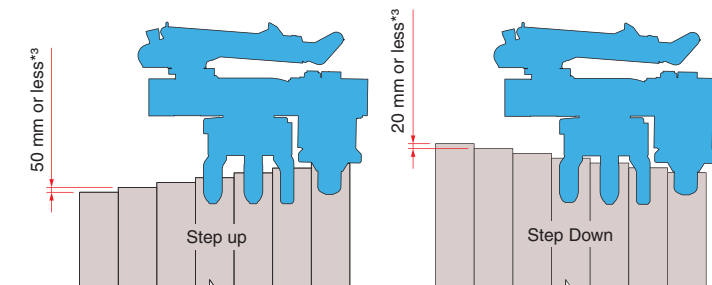

*3 These figures are only estimates based on ideal conditions. They cannot guarantee successful installation as the results may vary depending on factors such as the type of pile material and other conditions.

● Lifting Capacities

These values include boom deflections.

Radius	Boom 1.52 m 2.66 m		Boom 3.8 m	
	1.1 m or less			1.4 m or less
1.2 m			1.6 m	
1.4 m			1.8 m	
1.6 m	0.7 t	0.7 t	2.0 m	0.7 t
1.8 m			2.5 m	
2.0 m			3.0 m	
2.46 m			3.6 m	

● Lifting Heights & Working Radius

These values include boom deflections.

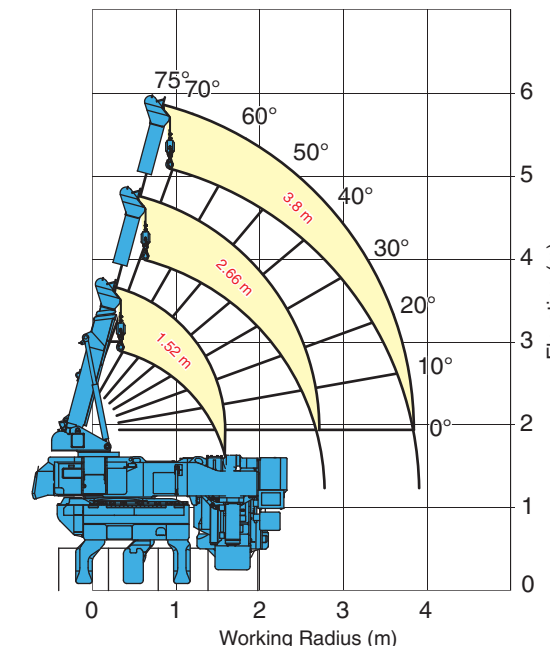

Low Emission Engine

A new generation of eco-friendly engines with Urea-SCR system ensures a high level of environmental friendliness.



Ultra Low Noise Level

It stays below the allowable construction noise levels in many industrialised countries.



Standard Application of Biodegradable Oil

If biodegradable oil happens to be spilled into soil or water, it does not harm the surrounding ecosystem.



New GIKEN IT System

The server automatically stores data on the operations and maintenance of press-in machines. This information can be analysed and used to provide effective support in different ways.

